

FITTINGS

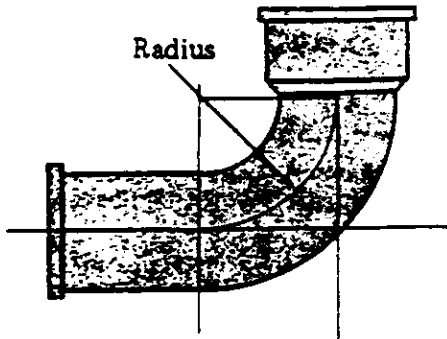

Short or long sweep 90 degree

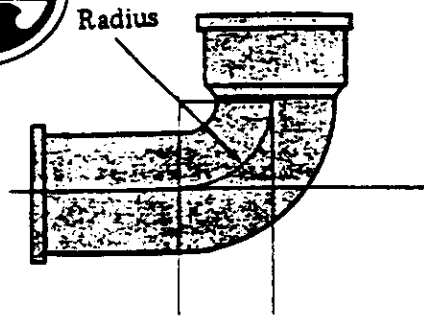

Short or long 1/4 bend 90 degree

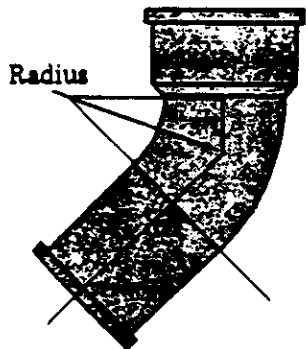

1/8 bend 45 degree illustrated
1/16 bend 22 1/2 degree

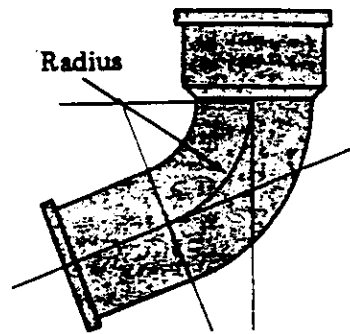

1/5 bend 72 degree illustrated
1/6 bend 60 degree

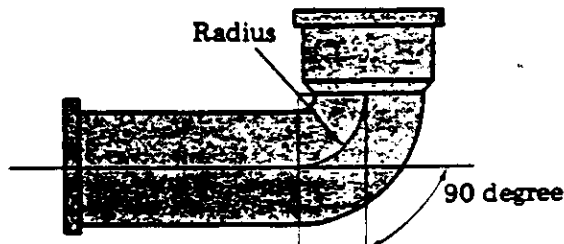

Low-hub 1/4 bend, also used to receive the waste from water closets, by caulking a lead stub into hub

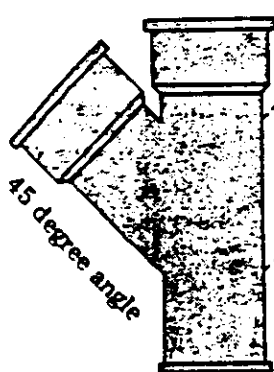

Y branches, single or double

Common bends

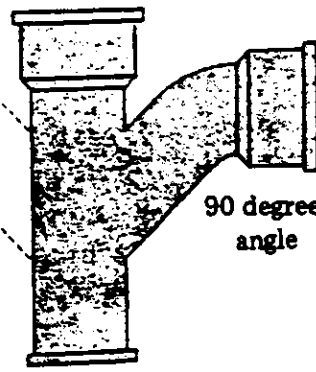

Combination Y and 1/8 bend
single or double

Wye (Y-branches)